

**FC370X2PE**

**GB**

**Instruction for use**

**FR**

**Notice d'utilisation**

**SV**

**Instruktionsmanual**

**D**

**Gebrauchsanweisung**







### **WARNING!**

In order to ensure a normal operation of your refrigerating appliance, which uses a completely environmentally friendly refrigerant the R600a (flammable only under certain conditions) you must observe the following rules:

- ♦ Do not hinder the free circulation of the air around the appliance.
- ♦ Do not use mechanical devices in order to accelerate the defrosting, others than the ones recommended by the manufacturer.
- ♦ Do not destroy the refrigerating circuit.
- ♦ Do not use electric appliances inside the food keeping compartment, other than those that might have been recommended by the manufacturer.

### **AVERTISSEMENT!**

Afin de s'assurer du fonctionnement normal de votre réfrigérateur, contenant le réfrigérant R 600a qui contribue à la protection de l'environnement (inflammable dans certaines conditions seulement), il convient de respecter les règles suivantes :

- ♦ Ne pas empêcher la circulation d'air autour de l'appareil.
- ♦ Ne pas utiliser d'outils mécaniques pour accélérer le processus de décongélation autres que ceux qui sont recommandés par le fabricant.
- ♦ Ne pas abîmer le circuit réfrigérant.
- ♦ Ne pas utiliser d'appareils électriques à l'intérieur des compartiments de conservation de denrées, à moins qu'ils soient conformes au type d'appareils recommandés par le fabricant.

### **VARNING!**

För att försäkra dig om en normal drift av din kylningsenhet, som använder ett miljövänligt kylmedel R600a (endast flambart under vissa förhållanden) måste du beakta följande regler:

- ♦ Förhindra inte att luften cirkulerar fritt runt enheten.
- ♦ Använd inte mekaniska enheter för att snabba på avfrostningsprocessen, förutom det som rekommenderas av tillverkaren.
- ♦ Skada inte kylningskretsen.
- ♦ Använd inte elektriska apparater inuti förvarningsfacket, förutom de som rekommenderas av tillverkaren.

### **WARNUNG!**

Ihr Gerät verwendet ein umweltverträgliches Kältemittel, R600a (nur unter bestimmten Umständen brennbar). Um einen einwandfreien Betrieb Ihres Gerätes sicherzustellen, beachten Sie bitte folgende Vorschriften:

- ♦ Die Luftzirkulation um das Gerät darf nicht behindert sein.
- ♦ Verwenden Sie außer der vom Hersteller empfohlenen, keine mechanischen Hilfsmittel, um den Abtauprozess zu beschleunigen.
- ♦ Der Kältemittelkreislauf darf nicht beschädigt werden.
- ♦ Verwenden Sie im Lebensmittelaufbewahrungsbereich Ihres Gerätes keine elektrischen Geräte, es sei denn, sie sind vom Hersteller empfohlen.

## EN Index

Safety comes first ! /1  
Transport instructions /2  
Disposal /2  
Device Setup /2  
Electrical connections /2  
Get to know your device /3  
Prior to startup /3  
Setting the operating temperature /3  
Cooling /5  
Freezing /6  
Defrosting of the device /6  
Changing the illumination lamp /7  
Cleaning and care /7  
Practical tips and notes /8  
Examples of use /9  
Placing the food /9  
Setting recommendation /9  
Normal operating noises /10  
Practical advice concerning the  
reduction of the electricity consumption /10  
What, if.... /11  
Reversing the doors /12

## FR Index

La sécurité d'abord ! /13  
Instructions de transport /14  
Mise au rebut /14  
Installation de l'appareil /14  
Branchements électriques /14  
Apprendre à connaître votre appareil /15  
Avant la mise en service /15  
Réglage de la température de fonctionnement /15  
Réfrigération /17  
Congélation /18  
Dégivrage de l'appareil /18  
Remplacement de la lampe /19  
Nettoyage et entretien /19  
Conseils pratiques et remarques /20  
Exemples d'utilisation /21  
Disposition des denrées /21  
Réglage recommandé /21  
Bruits normaux de fonctionnement /22  
Conseil pratique concernant la réduction de la  
consommation électrique /22  
Que faire si .../23  
Réversibilité des portes /24

## SV Index

Säkerheten först! /25  
Transportinstruktioner /26  
Installation av enhet /26  
Elektrisk anslutning /26  
Lär känna din enhet /27  
Innan uppstart /27  
Ställ in driftstemperaturen /27  
Kylning /29  
Frysning /30  
Avfrostning av enheten /30  
Byta lampan /31  
Rengöring och vård /31  
Praktiska råd och anmärkningar /32  
Exempel på användning /33  
Placering av mat /33  
Inställningsrekommendation /33  
Normala driftsljud /34  
Praktiska råd gällande reduktion av  
elförbrukningen /34  
Vad gör jag om... /35  
Byte av dörrar /36

## D Inhalt

Wichtige Hinweise zu Ihrer Sicherheit! / 37  
Transporthinweise / 38  
Entsorgung; Geräteaufstellung; Elektrischer  
Anschluss / 38  
Lernen Sie Ihr neues Gerät kennen / 39  
Vor der ersten Inbetriebnahme / 39  
Einstellen der Betriebstemperatur / 39  
Kühlen / 41  
Einfrieren; Abtauen des Gerätes / 42  
Beleuchtung auswechseln / 43  
Reinigung und Pflege / 43  
Praktische Tipps und Hinweise / 44  
Anwendungsbeispiele / 45  
Lebensmittel platzieren / 45  
Einstellungsempfehlungen / 45  
Normale Betriebsgeräusche / 46  
Praktische Tipps zum Energiesparen / 46  
Was mache ich, wenn... / 47  
Türanschlag umkehren / 48

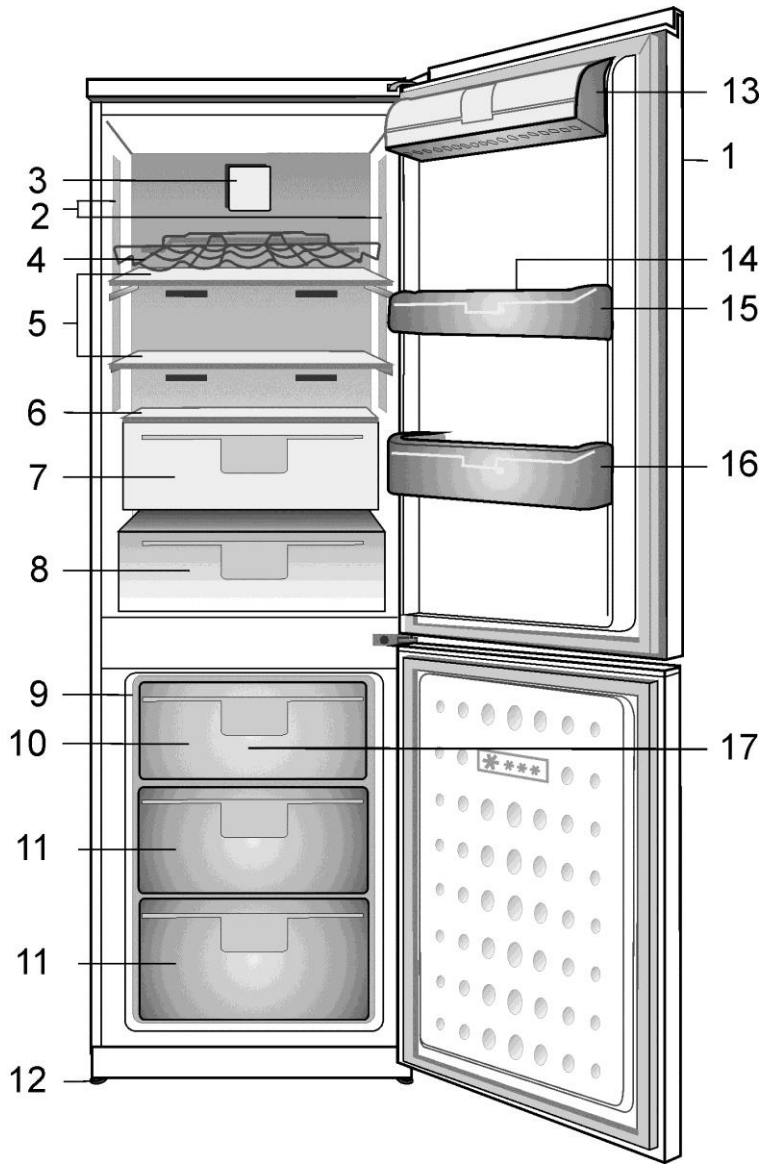

1

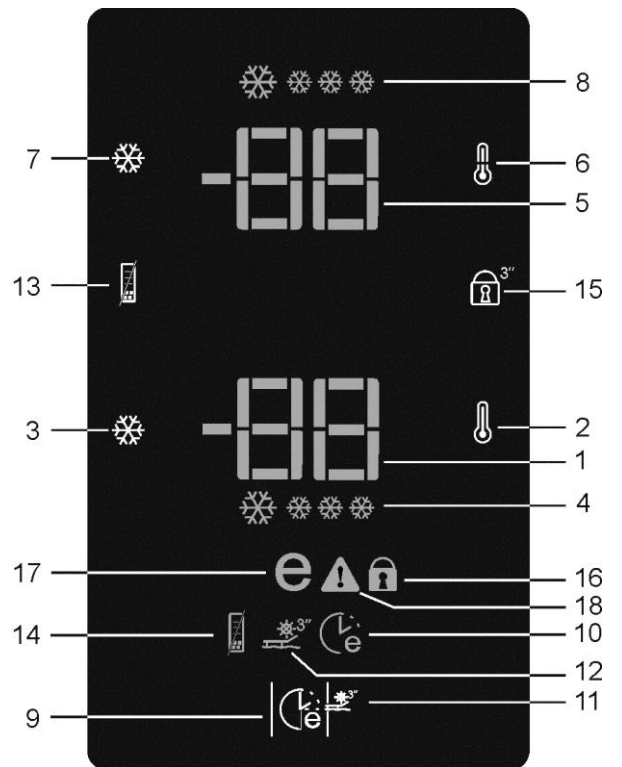

2

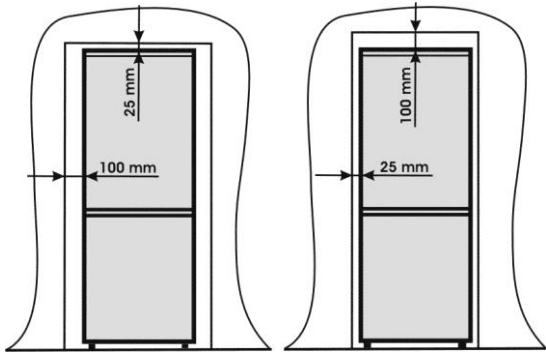

3

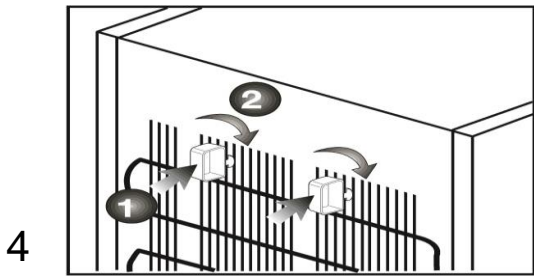
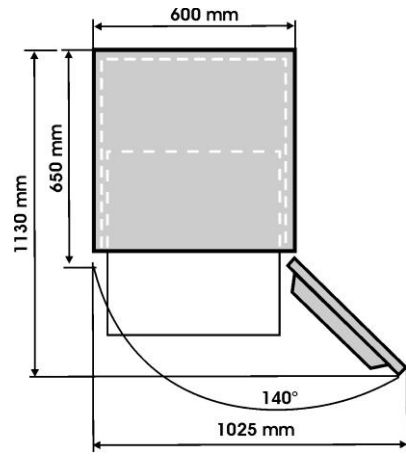

4

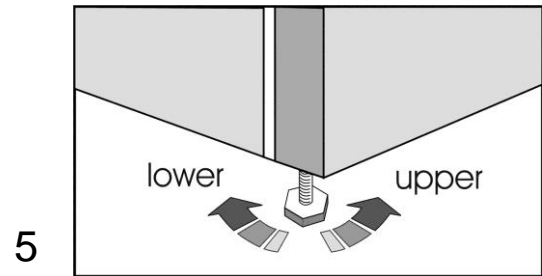

5

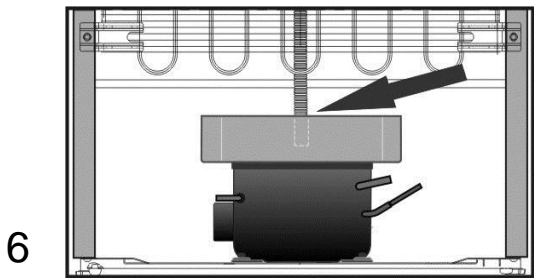

6

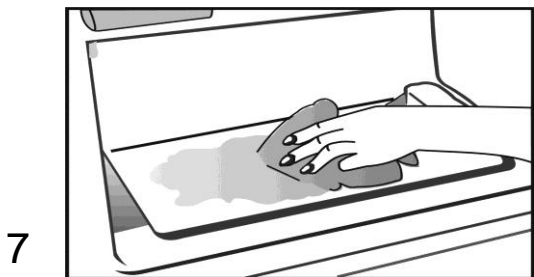

7

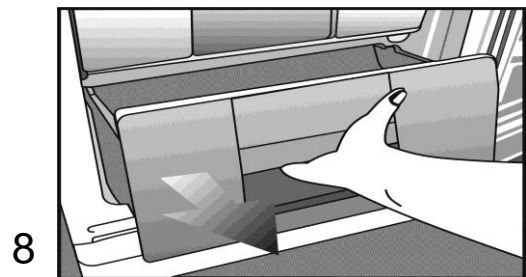

8

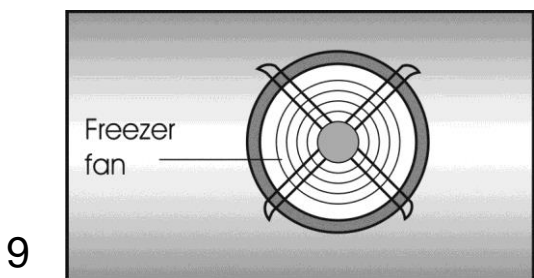

9

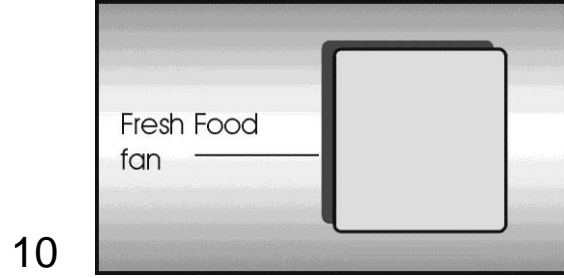

10

Congratulations on your choice of our product which will certainly provide you with many years of good service.

### ***Safety comes first!***

Please read the operating manual carefully. It contains important information on how to use your device. If instructions are not adhered to, you may lose your right to service at no charge during the warranty period. Please keep this manual in a safe place and pass it on to later users if applicable.

- Do not connect your appliance to the power supply until all packing and transit protectors have been removed.
- Leave to stand upright for at least 12 hours before switching on to allow the system to settle if transported horizontally.
- This appliance must only be used for its intended purpose, i.e. the storing and freezing of edible foodstuff.
- We do not recommend use of this appliance in an unheated, cold room e.g. garage, conservatory, annex, shed, outdoors, etc. See 'Location'.
- On delivery, check to make sure that the product is not damaged and that all the parts and accessories are in perfect condition.
- Do not operate a damaged appliance; if in doubt, check with your dealer.
- Do not allow children to play with the appliance.
- Do not sit or stand on or let the children sit or stand on the appliance or on the pull-out parts.
- Do not hang on the appliance door.
- Your device contains no fluoridated coolants (CFC/HFC), but contains the coolant isobutane (R600a), a natural gas which is highly compatible with the environment. (R600a) is easily flammable. Therefore, be sure that the cooling circuit is not damaged either during transport or during operations.  
In the event of damage;
  - Avoid any open flame, sources of sparks and flammable substances.
  - Immediately air the room in which the appliance is located.
  - In case the coolant spraying out contacts your eyes it may cause eye injuries.
- The space in the room where the appliance is installed must not be smaller than 10 cubic metres.
- Do not dispose of the appliance in a fire. Your appliance contains non CFC substances in the insulation which are flammable.
- Please contact the local authority in your region for information on disposal methods and facilities available.

 **Warning** - Keep ventilation openings on the appliance enclosure or in the built-in structure, clear of obstruction.

 **Warning** - Do not use mechanical devices or other means to accelerate the defrosting process, other than those recommended by the manufacturer.

 **Warning** - Do not damage the refrigerant circuit.

 **Warning** - Do not use electrical appliances inside the food storage compartments of the appliance, unless they are of the type recommended by the manufacturer.

- Avoid touching the metal condenser wiring on the backside of the appliance; there is risk of injury.
- In the event of a possible malfunction, disconnect the appliance from the power supply first.
- Prior to cleaning the device always unplug the power supply or shut off the fuse.  
Do not pull from the cable - pull from the plug.
- Repairs to the electrical equipment may only be made by qualified experts. If the supply cord is damaged, it must be replaced by the manufacturer, its service agent or similarly qualified persons in order to avoid a hazard.

## Transport instructions

The appliance should be transported only in upright position.

Before the performance of the working test in the shop, the packing of the appliance must be intact.

After a transport in the horizontal position, the device may only be taken into operation 12 hours after being stood up vertically again.

The appliance must be protected against rain, moisture and other atmospheric influences.

The manufacturer assumes no liability if safety instructions are disregarded.

### Disposal

Make the device unusable immediately.

Pull out the mains plug and cut the power cable. Remove or destroy snap or latch locks before disposing of the device. In this manner you prevent children from locking themselves in and endangering their lives.

## Device setup

- Do not operate your appliance in a room where the temperature is likely to fall below 10 °C at night and/or especially in winter. At lower temperatures the appliance may not operate, resulting in a reduction in the storage life of the food.

- The climate class rate of your appliance is given in Technical Features leaflet and written on the rating label inside the appliance. It specifies the appropriate operating ambient temperatures as explained below.

### Climatic class      Ambient temperatures

SN .....	+10 °C to 32 °C
N .....	+16 °C to 32 °C
ST .....	+16 °C to 38 °C
T.....	+16 °C to 43 °C
SN-ST.....	+10 °C to 38 °C
SN-T.....	+10 °C to 43 °C

## Location

Only place the appliance, as shown in the illustration in dry rooms which can be aired.

Avoid direct sunlight or direct heat sources such as a stove or a heater.

If this cannot be avoided, the following minimum distances should be maintained:

Electric stoves: 3,00 cm

Heater: 3,00 cm

Cooling devices: 2,50 cm

- Ensure sufficient air circulation for your device.
- Make sure that sufficient room is provided around the appliance to ensure free air circulation **(Item 3)**.

Fit the two plastic wall spacers supplied with the appliance rotating 1/4 turn to the condenser at the back of the appliance **(Item 4)**.

- The appliance should be located on a smooth surface. The two front feet can be adjusted as required **(Item 5)**. To ensure that your appliance is standing upright adjust the two front feet by turning clockwise or counter-clockwise, until the product is in firm contact with the floor.

Correct adjustment of feet avoids excessive vibration and noise.

## Electrical connections

### Warning

This appliance must be grounded.

- Check whether the power type and voltage in your region corresponds to the one stated on the rating label inside the appliance.
- The electrical safety of the appliance is only assured when the grounding system in the house is installed in accordance with regulations.
- When placing the appliance, do not let the power cable get stuck under it; otherwise the cable will be damaged.
- Ensure that the plug remains readily accessible. Do not use a multiple adapter bar or an extension cable.



## Get to know your device

### **Warning**

Below information about accessories are supplied just for reference. Below accessories may not be exactly same as the accessories of your appliance.

**Fig. 1**

1. Control panel
2. Interior light
3. Fresh Food fan
4. Wine rack
5. Movabale shelves
6. Crisper
7. Fresh zone compartment
8. Salad crisper
9. Ice tray support & ice tray
10. Compartment for quickly freezing
11. Compartments for frozen froods keeping
12. Adjustable front feet
13. Dairy Compartment
14. Egg tray
15. Shelf for jars
16. Shelf for bottles
17. Freezer fan

The fans has the purpose to provide the circulation of the air in compartment.

### **Prior to startup**

Before you begin operating your device, the following points should be re-checked for safety:

- Is the device standing properly on the floor?
- Is there sufficient space for good air circulation?
- Is the interior clean? (Also see the section "Cleaning and care")
- Now connect the appliance to the mains.

The compressor is turned on; the interior light comes on when the Fridge door is opened.

Do not place foodstuff into the refrigerator until the temperature has reached the desired level.

## Setting the operating temperature

Fresh Food and Freezer Compartment Temperature can be adjusted by the electronic display (**Item 2**)

### Control Panel

#### **Control Functions**

Considering Figure 2, the following functions are implemented on the appliance.

1. Freezer Compartment Temperature Indicator
2. Freezer Compartment Temperature Setting Function
3. Quick Freeze Function
4. Quick Freeze Indicator
5. Fridge Compartment Temperature Indicator
6. Fridge Compartment Temperature Setting Function
7. Quick Fridge Function
8. Quick Fridge Indicator
9. Eco-Fuzzy (Special Economic Usage) Function
10. Eco-Fuzzy (Special Economic Usage) Indicator
11. Vacation Function
12. Vacation Function Indicator
13. Energy Efficiency Function
14. Energy Efficiency Indicator
15. Key Lock Function
16. Key Lock Indicator
17. High Temperature/Error Warning Indicator
18. Economic Usage Indicator

## Description of the Control Functions

### 1. Freezer Compartment Temperature Indicator

Indicates the temperature set for Freezer Compartment.

### 2. Freezer Compartment Temperature Setting Function

This function allows you to set the freezer compartment temperature. Press this button to set the temperature of the freezer compartment to -18, -20, -22 and -24 degrees, respectively.

### 3. Quick Freeze Function

Quick Freeze indicator is illuminated when the Quick Freeze function is active. To cancel this function, press Quick Freeze button again. Quick Freeze indicator will turn off and return to its normal settings. If you do not cancel it, Quick Freeze will cancel itself automatically after 4 hours or when the freezer compartment reaches the required temperature. If you want to freeze large amounts of fresh food, press the Quick Freeze button before putting the food into the freezer compartment. If you press the Quick Freeze button repeatedly with short intervals, the electronic circuit protection will be activated and the compressor will not start up immediately. This function is not recalled when power restores after a power failure.

### 4. Quick Freeze Indicator

This symbol flashes in an animated style when the Quick Freeze function is active.

### 5. Fridge Compartment Temperature Indicator

Indicates the temperature set for the Fridge Compartment.

### 6. Fridge Compartment Temperature Setting Function

This function allows you to set the fridge compartment's temperature. Press this button to set the temperature of the fridge compartment to 8, 6, 4, 2 degrees, respectively.

### 7. Quick Fridge Function

When you press the Quick Fridge button, the temperature of the compartment will be colder than the adjusted values. This function can be used for food required to be cooled down rapidly in the fridge compartment. If you want to cool large amounts of fresh food, it is recommended to activate this function before putting the food into the fridge. Quick Fridge indicator is illuminated when the Quick Fridge function is active. To cancel this function, press Quick Fridge button again. Quick Fridge indicator will turn off and return to its normal settings. If you do not cancel it, Quick Fridge function will cancel itself automatically after 2 hours or when the fridge compartment reaches the required temperature. This function is not recalled when power restores after a power failure.

### 8. Quick Fridge Indicator

This symbol flashes in an animated style when the Quick Fridge function is active.

### 9. Eco-Fuzzy (Special Economic Usage) Function

When you press Eco-Fuzzy button, Eco Fuzzy Function will be activated and Eco-Fuzzy Indicator will illuminate. Refrigerator will start operating in the most economic mode at least 6 hours later and the economic usage indicator will turn on when the function is active. Press Eco Fuzzy button again to disable the Eco-Fuzzy function.

### 10. Eco-Fuzzy (Special Economic Usage) Indicator

This symbol illuminates when the Eco-Fuzzy Function is active.

### 11. Vacation Function

Press and hold Eco Fuzzy button for 3 seconds to activate Vacation Function and illuminate Vacation indicator. The cooling of Fridge Compartment is stopped and temperature of Fridge Compartment is fixed to 15 degrees to prevent bad odours. When this function is active, Fridge Compartment Temperature Indicator will not display the temperature. To deactivate Vacation Function, press and hold Eco-Fuzzy button for 3 seconds.

### 12. Vacation Function Indicator

This indicator illuminates when Vacation Function is active.

### 13. Energy Efficiency Function

When you press Energy Efficiency button, Energy Efficiency Function will be activated and Energy Efficiency Indicator will illuminate. When Energy Efficiency Function is active, all indicators, except for Energy Efficiency Indicator, will turn off. This function will be deactivated when any button is pressed or door is opened; display indicators will return normal settings and Energy Efficiency Indicator will stay illuminated. If you do not press any button or open the door within 5 minutes when Energy Efficiency Indicator is still illuminated, Energy Efficiency Function will be activated again and display indicators will turn off. If you press Energy Efficiency button when the function is not active but the indicator is still illuminated, this will deactivate Energy Efficiency function and turn off Energy Efficiency Indicator.

### 14. Energy Efficiency Indicator

This indicator illuminates when Energy Efficiency Function is selected.

### 15. Key Lock Function

When you press and hold Key Lock button for 3 seconds, Key Lock Function will be activated and Key Lock Indicator will illuminate. No button will operate when this function is active. Press and hold Key Lock button for 3 seconds to deactivate this function.

### 16. Key Lock Indicator

This indicator will illuminate when Key Lock Function is active.

### 17. High Temperature/Error Warning Indicator

This light illuminates during high temperature failures and error warnings.

### 18. Economic Usage Indicator

Economic Usage Indicator illuminates when the Freezer Compartment is set to -18°C. When Quick Freeze or Quick Fridge is selected, Economic Usage Indicator will turn off.

## Cooling

### Food storage

The **fridge compartment** is for the short-term storage of fresh food and drinks.

Store milk products in the intended compartment in the refrigerator.

Bottles can be stored in the bottle holder or in the bottle shelf of the door.

Raw meat is best kept in a polyethylene bag at the second shelf from the top of the refrigerator.

Allow hot foods and beverages to cool to room temperature prior to placing them in the refrigerator.

It is suggested not to keep frozen food over crisper cover for thawing purposes.

The other shelves can be used for thawing purposes.



#### Attention

Store concentrated alcohol only standing upright and tightly closed.



#### Attention

Do not store explosive substances or containers with flammable propellant gases (canned cream, spray cans etc.) in the appliance. There is a **danger of explosion**.

## Freezing

### Freezing food

The freezing area is marked with  symbol.

You can use the appliance for freezing fresh food as well as for storing pre-frozen food. Please refer to the recommendations given on the packaging of your food.



#### Attention

Do not freeze fizzy drinks, as the bottle may burst when the liquid in it is frozen.

Be careful with frozen products such as coloured ice-cubes.

Do not exceed the freezing capacity of your appliance in 24 hours. See Technical Features leaflet.

In order to maintain the quality of the food, the freezing must be effected as rapidly as possible.

Thus, the freezing capacity will not be exceeded, and the temperature inside the freezer will not rise.



#### Attention

Keep the already deep-frozen food always separated with freshly placed food.

When deep-freezing hot food, the cooling compressor will work until the food is completely frozen. This can temporarily cause excessive cooling of the refrigeration compartment.

If you find the freezer door difficult to open just after you have closed it, don't worry. This is due to the pressure difference which will equalize and allow the door to open normally after a few minutes.

You will hear a vacuum sound just after closing the door. This is quite normal.

### Making ice cubes

Fill the ice-cube tray 3/4 full with water and place it in the freezer.

As soon as the water has turned into ice, you can take out the ice cubes.

Never use sharp objects such as knives or forks to remove the ice cubes. There is a risk of injury!

Let the ice cubes slightly thaw instead, or put the bottom of the tray in water for a short moment.

## Defrosting of the device

**The appliance is a frost free refrigerator. So there will not be any frost accumulation inside the food storage area.**

However there will be an automatic defrost at the evaporation area of the appliance when it needs. The water drains into reservoir at the back of the appliance and evaporates automatically through the compressor heat.

Ensure that the reservoir is fixed properly above the compressor.



#### Warnings!

The fans inside the freezer and fresh food compartments circulates cold air. Never insert any object through the guard. Do not allow children to play with the fresh food and freezer fan.

Never store products that contain inflammable propellant gas (eg dispensers, spray cans etc.) or explosive substances.

Don't cover the shelves with any protective materials, which may obstruct air circulation.

Do not allow children to play with the appliance or tamper with the controls.

Do not obstruct the fan guards to ensure that you obtain the best possible performance from your appliance. **(Item 9 and Item 10)**

#### Warning!

Your appliance is fitted with 2 circulating fans which are essential for the performance of the refrigerator. Please ensure the fans are not blocked (stopped) or impaired by food or packaging. Blocking (stopping) or impairing the fan can result in an increase of the internal freezer temperature (Thawing).

## Changing the illumination lamp

To change the lamp used for illumination of your refrigerator, please call your Authorized Service.

## Cleaning and care

### Interior and Exterior Surfaces



#### Attention

**Always unplug the power cable or switch off the circuit breaker before cleaning.**

Clean the exterior using lukewarm water and a mild detergent.

Never use detergents, abrasive or acidic agents.

Wipe the inside compartment dry.

Be careful to prevent water from getting into contact with the electrical connections of the temperature control or the interior light.

If the device is not going to be used for a long period of time, unplug the power cable and remove all food. Clean the appliance and keep the door open.

To preserve the appearance of your appliance, you can polish the exterior and the door accessories with a silicone wax.

Clean the condenser at the back of the appliance once a year using a brush or a vacuum cleaner. Dust build-up leads to increased energy consumption.

Inspect the door gasket at regular intervals. Clean with water only, and wipe totally dry.

## Cleaning of the accessories

### Door shelves:

Remove all food from the door shelves. Lift the cover of the shelf upwards and pull it off sideward.

Remove the bottom of the door shelf by pushing it upwards.

### Collecting container (Pan):

Make sure that the pan at the back of the appliance is always clean.

Gently release the snap of the pan from the compressor by pushing it using a tool (like screwdriver), so that the pan can be removed.

Lift the pan, clean it and wipe it dry.

Re-assemble in reverse order.

### Crisper or Drawers:

To clean a drawer, pull it out as far as possible, tilt it upwards and then pull it out completely (**Fig. 7-8**).

## **Practical tips and notes**

### **Cooling**

- Clean fresh food and vegetables before storing in the crisper bin.
- Always pack or wrap food, or put it in a suitable container, before storing it in the appliance.
- Wrap food which is not suitable for storage at cold temperatures in polyethylene bags (pineapple, melons, cucumbers, tomatoes etc.).
- Food with strong odour or apt to acquire odour should be wrapped in airtight or smellproof packaging material.
- Keep fresh food separate from cooked food, to avoid bacteria contamination.
- Never keep fresh meat in the fridge for more than 2 or 3 days.
- Remove any left-over canned food from the can and store it in a suitable container.
- Refer to the shelf life indicated on the food packaging.
- Do not obstruct the air circulation inside the device by covering the shelves.
- Never keep any dangerous or poisonous substances inside your device.
- Always check food that has been stored for a long period of time for its suitability for consumption.
- Do not store fresh and cooked food together in the same container.
- Close the door immediately after opening, to avoid unnecessary energy consumption.
- Do not use hard or sharp objects to remove the ice build-up.
- Do not load hot food into your appliance.

### **Freezing**

- Always leave food to thaw in a container that allows the thawing water to run off.
- Do not exceed the maximum allowable freezing capacity when freezing fresh food (see the section "Freezing").
- Do not give children ice-cream and water ices direct from the freezer.  
The low temperature may cause freeze burns on lips.
- Never re-freeze defrosted food; defrosted food must be consumed within 24 hours. Only food that has been cooked can be refrozen.
- Do not take out frozen food with wet hands.
- Store only fresh and impeccable food.
- Always use appropriate packaging material to avoid odour penetration or degradation of the food.
- Store commercially frozen food in accordance with the instructions given on the packaging.
- Freeze cooked food in small quantities. This ensures rapid freezing and maintains the quality of the food.
- Do not freeze liquid in tightly closed bottles or containers.  
The bottles/containers may burst at low temperatures.
- Carry pre-frozen food in suitable bags and place it in your freezer as soon as possible. Always defrost food in the fridge compartment.

**Examples of Use**

White wine, beer and mineral water	chill before use
Bananas	do not store in a fridge
Fish or offal	store in polyethylene bags only
Cheese	use airtight containers or polyethylene bags; for best results, take out from the fridge an hour before consumption.
Melons	store only for a short period of time, use airtight packaging/wrapping
Raw meat and poultry	do not store together with delicate food such as cooked food or milk

**Placing the food**

Freezer compartment shelves	Various frozen food such as meat, fish, ice cream, vegetables and etc.
Egg holder	Egg
Fridge compartment shelves	Food in pans, covered plates and closed containers
Fridge compartment door shelves	Small and packaged food or drinks (such as milk, fruit juice and beer)
Crisper	Vegetables and fruits
Fresh zone compartment	Delicatessen products (cheese, butter, salami and etc.)

**Setting recommendation**

Freezer Compartment Adjustment	Fridge Compartment Adjustment	Explanations
-18 or -20°C	4°C	This is the normal recommended setting.
-22 or -24°C	4°C	These settings are recommended when the ambient temperature exceeds 30°C.
Quick Freeze	4°C	Use when you wish to freeze your food in a short time. Your refrigerator will return to its previous mode when the process is over.
-18°C or colder	2°C	If you think that your fridge compartment is not cold enough because of the hot conditions or frequent opening and closing of the door.
-18°C or colder	Quick Fridge	You can use it when your fridge compartment is overloaded or if you wish to cool down your food rapidly. It is recommended that you activate quick fridge function 4-8 hours before placing the food.

## **Normal operating noises**

**Various functional noises are completely normal due to the operation of the cooling system of your appliance;**

- Gurgling, hissing, boiling or bubbling noises are caused by the refrigerant, circulating inside the cooling system. These noises can still be heard for a short period of time after the compressor shuts off.
- Sudden, sharp cracking or popping noises are caused by the expansion and contraction of the inside walls or some components inside the cabinets.
- Buzzing, whirring, pulsating or high-pitched humming noises are caused by the compressor. These noises are slightly louder at the start-up of the compressor and reduce when the appliance reaches the operating temperatures.

## **Also to avoid disturbing vibrations and noises make sure that;**

- Your refrigerator is standing level on all four feet.
- Your refrigerator is not in contact with the walls, surrounding objects or kitchen cabinets and furniture.
- Cans, bottles or dishes inside the refrigerator are not touching and rattling against each other.
- All shelves and bins are mounted correctly inside the refrigerator cabinets and doors.

## **Practical advice concerning the reduction of the electricity consumption**

1. Make sure that the appliance is located in well-ventilated areas, far from any source of heat (cooker, radiator etc.). At the same time, the location of the appliance must be done in such a way that it prevents it to be under the direct incidence of the sunbeams.
2. Make sure that the food purchased in refrigerated/frozen condition is placed into the appliance as soon as possible, especially during summertime. It is recommended to use thermal insulated bags to transport the food home.
3. We recommend the thawing of the packets taken out from the freezer compartment be done in the refrigerator compartment. For this purpose, the packet which is going to be thawed will be placed in a vessel so that the water resulting from the thawing does not leak in the refrigerator compartment. We recommend you to start the thawing at least 24 hours before the use of the frozen food.
4. We recommend reducing the number of door openings to the minimum.
5. Do not keep the door of the appliance open more than necessary and make sure that after each opening the door is well closed. When doors are open, warm air enters the fridge/freezer cabinets and the appliance consumes more energy to cool down the foodstuffs. Thus please do not open doors frequently in order to save energy and to keep foods at ideal storage temperature.
6. Maximum frozen food storage volume is achieved without using the middle and upper drawer provided in the freezer compartment. Energy consumption of your appliance is declared while the freezer compartment is fully loaded without using the middle and upper drawer.
7. Do not block the freezer fan grill by placing foods in front. There must always be left minimum 3 cm open distance in front of the freezer fan grill to allow necessary air flow to freeze the compartment efficiently.
8. If you do not plan to store foodstuff in freshfood compartment, please activate Eco Fuzzy function for energy saving. Freezer compartment keeps freezing normally.
9. Activate "Energy Saving Function". When energy Saving Function is active, all icons on the display will turn off except energy saving icon. All icons will be lightened, if freshfood door is opened or display is touched.
10. Recommended temperature settings are +4°C and -20°C for freshfood and freezer compartments respectively.



**What, if....****1- The appliance will not work, even though it is switched on.**

- Check if the power cable is properly connected!
- Check if the mains supply is in order, or if a circuit breaker has been tripped!
- Check the temperature control for correct setting!

**2- There is a power failure.**

Keep the doors of your device closed. Frozen food will not be affected if the power failure lasts less than the 'Conservation Time From Failure' (hours) declaration mentioned in the Technical Features leaflet. If the power failure lasts longer, check the food and consume it immediately.

You can also cook the defrosted food and then re-freeze it.

**3- The interior light does not work.**

Please call your Authorized Service.

**4- There is high temperature alarm**

If the actual temperature of the freezer compartment is warm then the alarm icon on the display (**Fig. 2/18**) lights on. The alarm icon lights off when the actual temperature of the freezer compartment cools down.

The high temperature alarm may rise up due following situations.

- a) Warm food storage
- b) Warm air in the freezer compartment
- c) Freezer door is left open for a long time

If the high temperature alarm remains on for more than 24 hours then contact with the customer service.

The high temperature alarm is not active in 24 hours after plugging the appliance into the electricity.

**5- There is error messages and alarm**

Incase any failure condition due wiring connection of the appliance occurs, and then the alarm icon on the display (**Fig. 2/18**) starts blinking together with the relevant error message.

Incase some certain characters (E0, E3, ..etc.) appear on the display then contact with the customer service.

The alarm icon lights off just after the removal of the failure.

**6- There is actual fridge temperature failure**

The appliance performs cooling considering the fridge set temperature. The actual fridge temperature shown on the display will reach the adjusted fridge set temperature, when the packages are cold enough.

There may be some oscillations on the actual fridge temperature shown on the display due;

- a) The fridge door is Opened / Closed frequently
- b) Loading warm packages inside the fridge.
- c) Leaving the fridge door open for a long period of time

**7- There is actual freezer temperature failure**

The appliance performs cooling considering the freezer set temperature. The actual freezer temperature shown on the display will reach the adjusted freezer set temperature, when the packages are cold enough.

There may be some oscillations on the actual freezer temperature shown on the display due;

- a) The freezer door is Opened / Closed frequently
- b) Loading warm packages inside the freezer
- c) Leaving the freezer door open for a long period of time

## 8- Other possible malfunctions

Not every malfunction is a case for our customer service. Very often, you can easily resolve the problem without requesting service.

Before requesting service, please check if the malfunction has been caused by an operating error. If this is the case, and a service has been requested, a service charge will be levied even if the device is still under guarantee.

If the problem persists please contact your dealer or customer service.

Please have the type and serial number of your device when calling. The rating label is located inside.

## Door Open Alarm

There is a built in buzzer in the appliance that will inform customer if the fridge door is left open for a minute. This alarm is a periodic alarm and it reminds the customer that the fridge door is left open.

There is no buzzer alarm related to freezer door.

In order to stop the door open alarm, it is enough to press any button on the display or close the door. Thus the alarm will stop till next time.

## Reversing the doors

The door of your refrigerator is designed to operate towards both sides at your convenience. If you want the door to open towards the other side, please call the nearest authorized maintenance service for assistance.



The symbol  on the product or on packaging indicates that this product may not be treated as household waste. Instead it shall be handed over to the applicable collection point for the recycling of electrical and electronic equipment. By ensuring this product is disposed of correctly, you will help prevent potential negative consequences for the environment and human health, which could otherwise be caused by inappropriate waste handling of this product. For more detailed information about recycling of this product, please contact your local city office, your household waste disposal service or the shop where you purchased the product.

**This appliance is not intended for use by person with reduced physical, sensory or mental capabilities or lack of experience and knowledge unless they have been given supervision or instruction concerning use of the appliance by a person responsible for their safety.  
Children should be supervised to ensure that they do not play with the appliance.**